

E·VALUE

電動車專用AC充電設備
壁掛式交流充電器
完整操作指引手冊

ELECTRIC VEHICLE AC CHARGER
WALL-MOUNT EV CHARGER
OPERATING INSTRUCTION MANUAL

目錄

1. 產品資訊	4
1.1 產品外觀	5
1.2 產品規格	6
1.3 檢查內容物	7
2. 充電器安裝步驟	8
2.1 漏電斷路器額定功率 / 最大輸出	9
2.2 工具及材料	9
2.3 壁掛式充電器安裝步驟	10
3. 操作說明	20
3.1 RFID 感應卡充電操作步驟	21
3.2 延時充電時間設定	23
3.3 隨插即用充電操作步驟	26
4. 故障燈號顯示與排除	28
5. 充電器品質保養	32
5.1 壁掛式充電器設備簡易保養	33
5.2 壁掛式充電器產品保固說明	33
5.3 免責聲明	34

⚠ 重要安全警告

本手冊為電動車專用 AC 充電設備 (又稱 EVALUE 家充第二代壁掛式充電器，以下簡稱：壁掛式充電器) 快速使用指引，為確保本產品正確使用方式與使用安全，使用本產品前，請先檢閱所有警告與注意事項，在安裝與使用壁掛式充電器。產品安裝、操作與維護請遵循指示使用。

請注意：若在不正確的安裝、或不正常操作下，造成設備或財物損壞及人員傷亡，華城電能科技股份有限公司 (簡稱華城電能) 皆不負任何法律責任與損害賠償責任，須自行負責。

- 安裝及使用壁掛式充電器時，請務必遵循包含以下事項的基本預防措施。
- 壁掛式充電器應由華城電能訓練之合格人員進行安裝及檢修壁掛式充電器。若非由華城電能訓練之合格人員進行安裝，華城電能無法對其安裝正確性及安裝品質負責。

⚠ 火災與觸電風險相關指示說明

- 請勿在具易燃性、易爆性、刺激性或可燃性物質、化學物品或氣體環境安裝及使用壁掛式充電器。
- 安裝或清潔壁掛式充電器之前，必須先關閉電力來源的漏電斷路器開關。

⚠ 警告事項

- 運送壁掛式充電器時，請勿讓壁掛式充電器承受強大作用力或衝擊力，或拉動、扭曲、纏結、拖曳或踩踏壁掛式充電器，以防止機體或任何元件受損。
- 使用本裝置充電時，若周遭環境有孩童，請注意是否有無靠近，以確保使用者及孩童安全。
- 壁掛充電器必須要有接地迴路。
- 依照最大輸出功率挑選相對應認證過指定型號的漏電斷路器。
- 壁掛充電器必須具備獨立電源迴路，切勿與其他設備使用同一迴路。
- 場勘時必須先量測輸入電源空載時電壓須高於 200VAC，若電壓低於 200VAC 在車輛充電時有可能會造成電壓過低而無法充電。
- 安裝時請嚴格遵循所指定的工作參數使用壁掛式充電，避免充電器損壞。
- 安裝漏電斷路器所使用的電力箱 (動力箱)，必須具備防水功能。
- 禁止將水或任何其他液體直接噴灑在電力箱內部，或將任何液體噴灑充電槍頭及浸入液體中。
- 禁止對壁掛式充電器的本體及充電槍線組的任何零件施加任何壓迫力，或使用尖銳的物體破壞。
- 禁止用手指或將異物 (例如電線、工具或針等)，插入壁掛式充電器本體及充電槍線組末端內 (充電槍頭內)。
- 使用完畢後請將充電槍安插於槍線基座上，防止浸水或掉入污染物中。

- 當電源線進線處、壁掛式充電器及槍線有破裂或損壞以致無法使用或操作，請勿繼續使用，並請立即通知華城電能安排人員檢修及測試。
- 壁掛式充電器有維修或改裝需求，請通知華城電能安排人員檢修及測試。
- 在未完成正常斷電程序步驟，切勿任意插拔充電槍。
- 使用壁掛式充電器有可能會影響醫療或植入式電子設備的運作，例如植入式心臟起搏器或植入式心臟除顫器等。請先與醫生討論進行諮詢。

⚠ 注意事項

- 壁掛式充電器僅限電動汽車使用。
- 充電過程如發生緊急狀況，如人員觸電、車端異常…等，請立即按下左側紅色緊急按鈕，馬上停止充電。
- 禁止使用發電機作為充電電源使用，使用發電機產生的電源將可能對壁掛式充電器造成損壞。
- 不正確的安裝、或不正常操作下，所造成設備或財物損壞及人員傷亡，華城電能皆不負任何法律責任與損害賠償責任，須自行負責。
- 本充電設備需搭配合格認證之無熔絲開關過載保護器和漏電保護斷路器同時使用方可符合國家 BSMI 之 VPC (Voluntary Product Certification; 自願性產品驗證) 認證規定，安裝上若有問題請與華城聯繫諮詢或購買合格料件，若非使用合格認證之無熔絲開關過載保護器和漏電保護斷路器，造成本充電設備異常或出現其他問題由使用者自行負責。
- 禁止使用轉接器或轉換轉接器。
- 禁止使用延長線組。

產品資訊

01

1.1 產品外觀

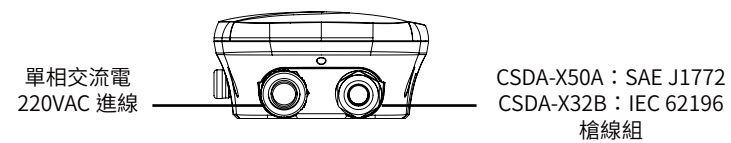
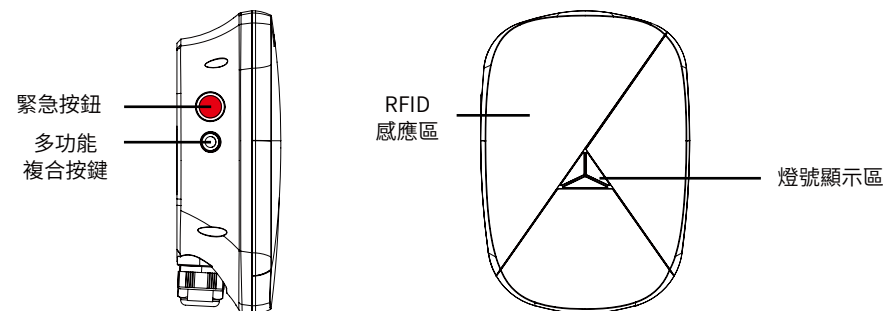

1.2 產品規格

機種型號	CSDA-X32A、CSDA-X32B
輸入電壓規格	額定 200-240V 單相交流電
輸出電流 (A) / 輸出功率 (kW)	32A / 7.04 kW
頻率範圍	60 Hz
充電槍規格	CSDA-X32A：SAE J1772 / CSDA-X32B：IEC62196
電纜線長	5 米
充電器外觀尺寸	長 318 x 寬 219 x 深 136 (單位：毫米)
重量 (包含充電槍線)	9.62 公斤
按鈕	紅色緊急停止開關、多功能複合按鍵
指示燈號	待機：綠色 充電中：藍色 完成充電：綠色 錯誤：紅色 延時充電：8 小時 / 粉紅色、4 小時 / 黃色、2 小時 / 青色、1 小時 / 白色
使用者身份辨識	RFID 讀卡機
WiFi 網路	無線網路功能 (註：此功能只限 OCPP 後台主機連線用，家用壁掛式充電器不適用)
保護功能	過電壓保護、過電流保護、短路保護、漏電保護、防雷擊保護、電壓過低保護
操作溫度	-20° C 至 50° C
儲存溫度	-25° C 至 70° C
濕度	<95% 相對溼度
IP 防塵防水等級	IP55

⚠ 警告：須確保壁掛式充電器在移動、運送或存放時都符合適當的儲存溫度

(註：完整系列機種規格請查 P34)

1.3 檢查內容物

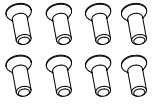
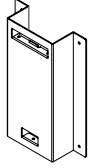
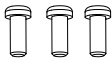
項目	說明		數量
1	壁掛架：充電器鎖附鐵件		2
2	壁掛架：皿頭螺絲 (M3 X 8L)		8
3	壁掛架：牆面 / 立柱鎖附鐵件		1
4	壁掛架：圓頭螺絲 (M4 X 12L)		3
5	電纜鉤		1
6	充電槍座和電纜鉤內六角 (M4X12L)		4
7	墊圈		4
8	充電槍座		1
9	RFID 感應卡和使用說明書		1 組

充電器安裝步驟

02

⚠ 警告：壁掛式充電器應由華城電能訓練之合格人員進行安裝及檢修壁掛式充電器，如由非華城電能訓練之合格人員安裝及檢修而造成設備或財物損壞及人員傷亡，華城電能皆不負任何法律責任與損害賠償責任，須自行負責。

⚠ 注意：場勘時請確實確認安裝場地之最大承載電流。

2.1 漏電斷路器額定功率 / 最大輸出

- 若需最大功率輸出 50A，請安裝標準 2P/60 安培的漏電斷路器。
- 以下為各輸出功率相對應的漏電斷路器選擇表：

漏電斷路器 (安培)	最大輸出 (安培)	功率輸出：kW(@220Vac)
20	16	3.5
30	24	5.2
40	32	7
50	40	8.8
60	50	11

2.2 工具及材料

- 鉛筆或簽字筆
- 電工鉗
- 剝線鉗
- 2mm²~14mm² 壓接鉗
- 捲尺
- 三用電表或數位萬用電表
- 十字螺絲起子
- 小型平頭螺絲起子
- 水平儀
- 電鑽及鑽頭
- 塑膠壁虎
- 圓型端子 R8-6
- 扭力起子

2.3 壁掛式充電器安裝步驟

2.3-1 使用支架作為指引，在安裝牆面上標記鑽孔位置如下尺寸標示圖。

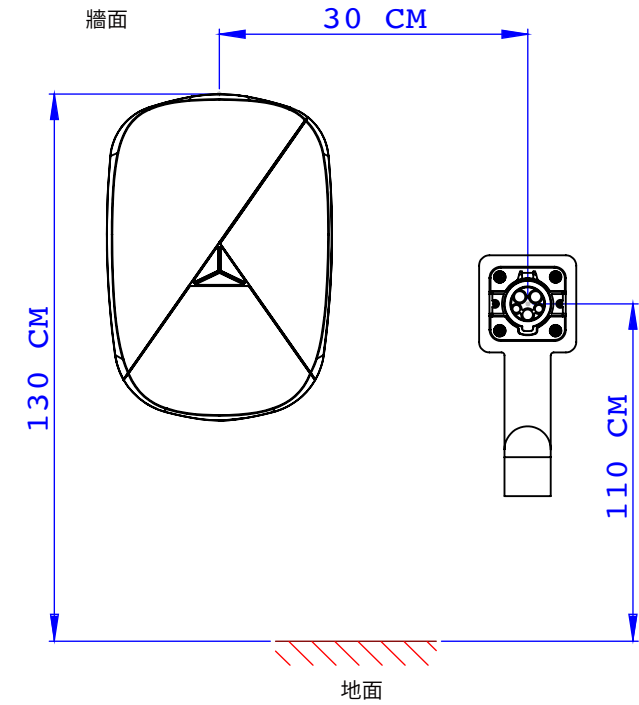
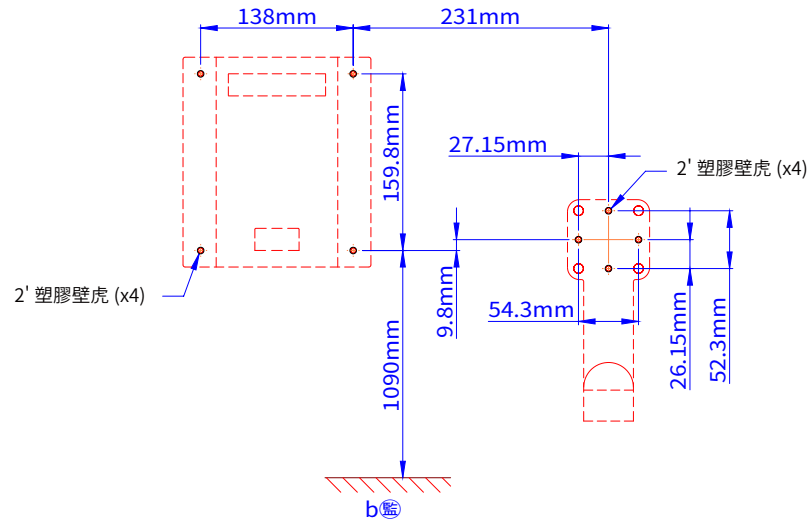

- 使用 5.8mm 水泥鑽頭鑽孔，並將 2 分塑膠壁虎埋入孔中。
- 使用螺絲將壁掛架 (注意壁掛架方向) 鎖固於牆面。

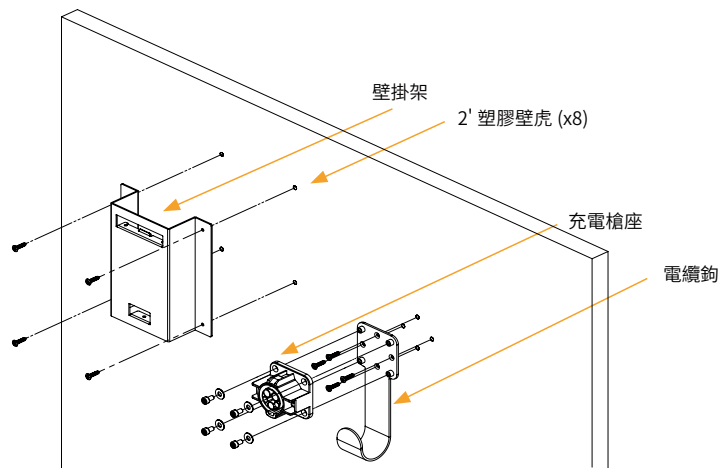

2.3-2 壁掛架掛勾及電纜線掛勾組裝

- 使用附件螺絲包中的 M3 皿頭螺絲將壁掛架上掛勾與下掛勾固定於充電器背板。
- 使用附件螺絲包中的 M4 圓頭螺絲將充電槍電纜線掛勾固定於充電器右下方。

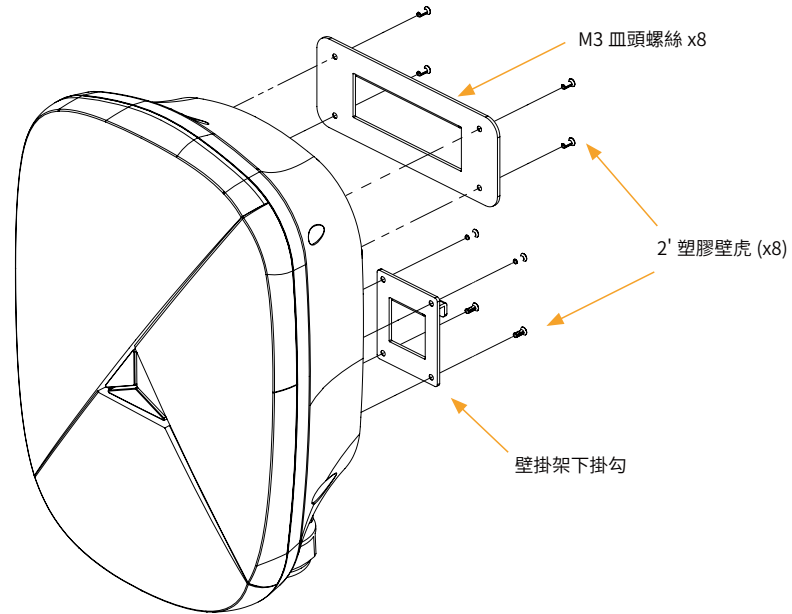

2.3-3 電纜線安插準備

- 使用十字螺絲起子將充電器外蓋殼及內密封板卸除。
- 請謹慎將外蓋殼左右及下方的十字皿頭螺絲卸除，並取下外蓋。
- 請謹慎將內密封板正面四個角落的十字圓頭螺絲卸除，並取下密封板。

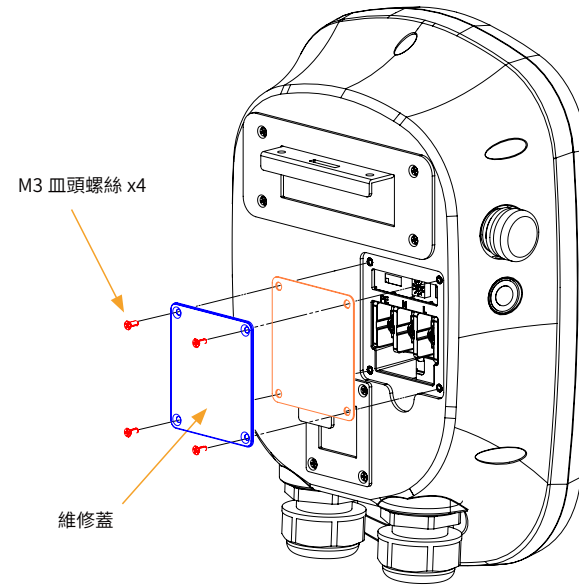

2.3-4 確認需求電流及檢測調整輸出電流

壁掛式充電器預設充電電流為 50A，依照案場勘表內提供的最大承載電流確認是否需調整輸出電流，如需調整輸出電流請參閱下表。

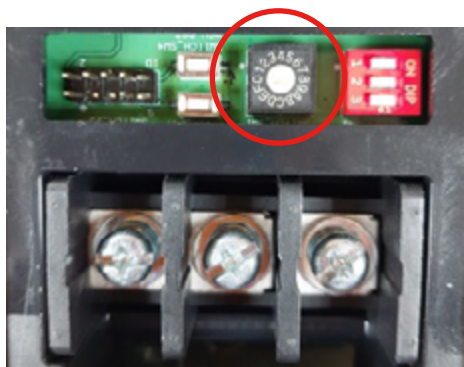

輸出電流調整開關

	輸出電流
0	Default(50A)
1	40A
2	32A
3	24A
4	16A
5	—

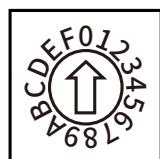

2.3-5 壁掛式充電器使用模式設定

壁掛式充電器，可依需求調整為單機或感應卡認證兩種模式，相關指撥開關設定方式如下；

⚠ 注意：場勘時請先確認設備使用模式需求及有無額外購買 RFID 感應卡需求。

項目	指撥開關設定
RFID 感應卡認證	
單機隨插即用 (預設值)	
網路模式 (註：此功能只限 OCPP 後台主機連線用， 家用壁掛式充電器不適用)	
全卡模式	

2.3-6 電纜線配線

- 若要配接最大功率，導線最低需使用 6 AWG (14mm²)、90° C 電纜線 XLPE。
- 將電纜線由充電器本體下方的電纜固定頭進線，並將電纜線固定於端子台上。
- 逆時針旋轉鬆開進線口的電纜固定頭，將電纜線穿入約 10~15cm 後順時針旋轉鎖緊電纜固定頭，並稍微拉扯確認電纜線不會移動。
- 將電纜線的 L1、L2 與接地電線分別壓接圓型端子後使用扭力起子鎖附於端子台上的 Lin、Nin 與 GND (PE) 上 (4N·m)，並將端子座透明保護蓋裝回。(# 備註：L1、L2 與 GND 接地電線的線色需依各國家或地區法規標示)。
- 使用三用電表或數位電表量測充電器前端漏電斷路器開關一次側電壓，並確認輸入電壓是否為 220V ± 10%，確認無誤後打開漏電斷路器量測充電器內端子台電壓是否正確。

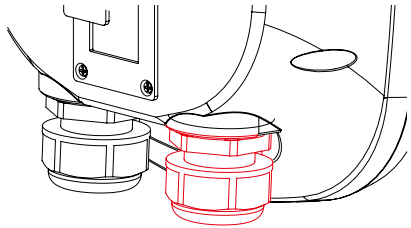

電纜線進線處



充電器內端子台

2.3-7 通電檢測及組裝

- 依序將內密封板及外蓋板鎖回 (需注意密封板與外蓋殼是否與本體完全貼合)。
- 將充電器鎖附於壁掛架或是立柱上。
- 將充電器本體掛到固定在牆面上的支架，並使用附件螺絲包中的 M4 圓頭螺絲將上掛勾與支架固定如下圖所示。

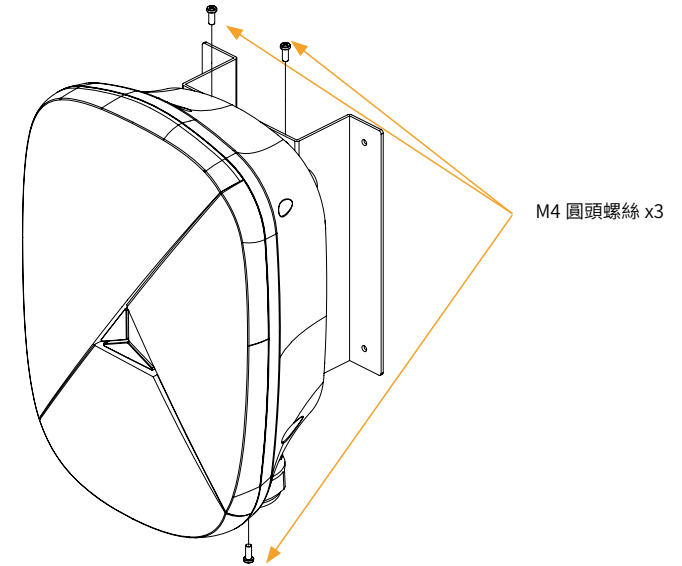

- 開啟電力來源的漏電斷路器開關。
- 通電後充電器啟動開機自我檢測完成後，進入待機狀態，此時面板燈號顯示為綠色呼吸燈，如右圖所示。

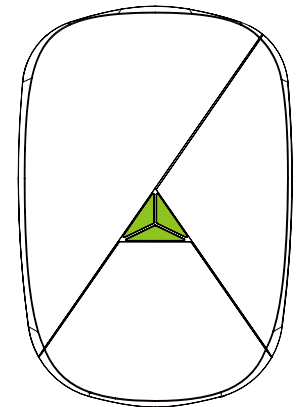

2.3-8 接線圖

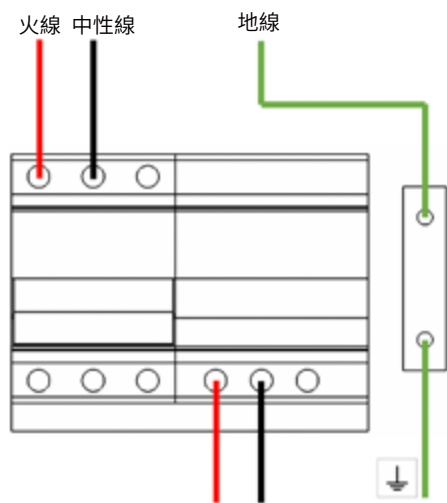

樣式 1

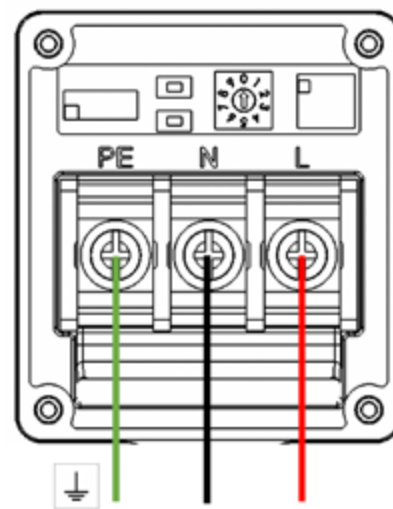

進線圖

- L ——— 火線
- N ——— 中性線
- PE ——— 地線

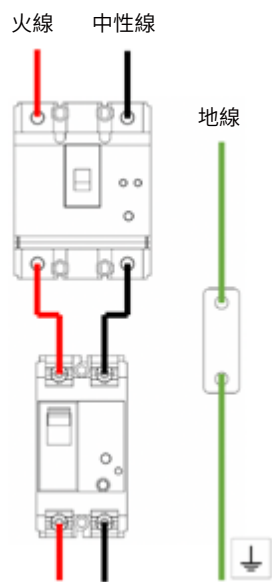

樣式 2

操作說明

03

3.1 RFID 感應卡充電操作步驟如下：

(步驟 1) 開啟輸入電源側的漏電斷路器開關，當壁掛式充電器完成開機自我檢測後，面板燈號顯示為綠色呼吸燈如下圖所示，則表示已進入待機樁狀態 (備註：如已開啟電力來源的漏電斷路器，此步驟可忽略)。

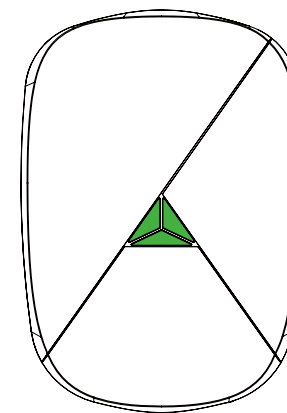

(步驟 2) 將壁掛式充電器的充電槍插到電動車充電接口內。

(步驟 3) 將 RFID 感應卡貼近位於壁掛式充電器面板左側的 RFID 感應卡感應區 (如下圖所示)，會聽到一聲「嗶」的聲音。

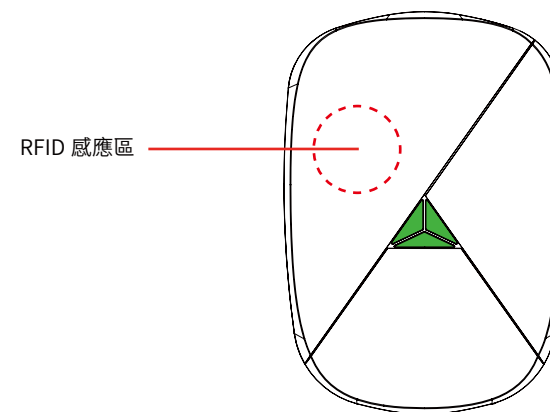

(步驟 4) 當感應成功後，充電器面板燈號顯示藍色呼吸燈，如下圖所示，表示已正在通電，同步可從車端儀表確認相關充電資訊。

⚠ **注意：**若聽到三聲短促的「嗶嗶嗶」聲音及亮紅燈 1 秒後再回綠色呼吸燈的待機狀態，則表示感應失敗，請確認所持的感應卡是否為說明書內所附的 RFID 感應卡，若是正確請從 (步驟 3) 重新操作。

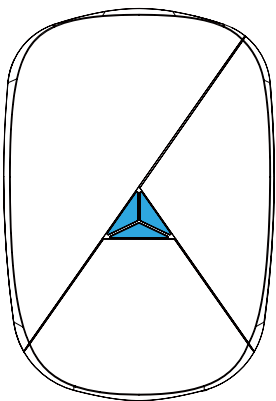

(步驟 5) 當車端資訊顯示充電完成時，壁掛式充電器面板燈號顯示綠色呼吸燈，如下圖所示；或是充電過程中欲停止充電，請再將 RFID 感應卡貼近位於壁掛式充電器面板左側的 RFID 感應區，聽到一聲「嗶」的聲音後，即代表結束充電，並依該車型之停止充電解鎖程序完成後，再將充電槍自電動車充電接口脫離。

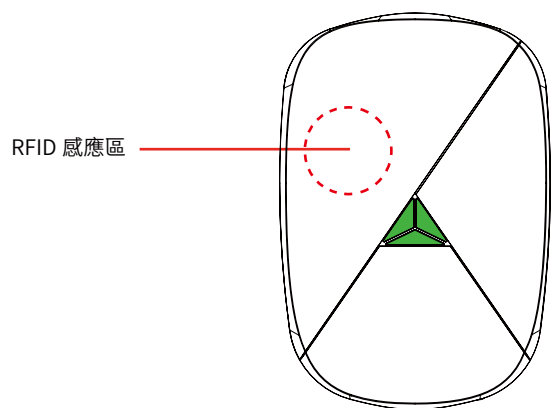

3.2 延時充電時間設定



本充電器具有延時充電功能，延時的時間分別為 1、2、4 及 8 小時，當完成設定後即開始倒數計時，不同的延時時間對應不同顏色所示，相關設定及操作步驟如下。

⚠ **注意：**本設備延遲充電功能適用性需視車款而定。

(步驟 1) 開啟輸入電源側的漏電斷路器開關，當壁掛式充電器完成開機自我檢測後，面板燈號顯示為綠色呼吸燈如下圖所示，則表示已進入待機樁狀態 (如已開啟電力來源的漏電斷路器，此步驟可忽略)。

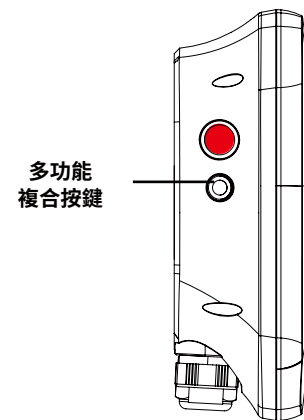
(步驟 2) 長按 10 秒多功能複合按鈕進入延時充電功能設定，選擇欲延時充電時間所對應的面板燈號顏色 (請見下表)，選定之後等待 3 秒將儲存此次的延時充電設定。

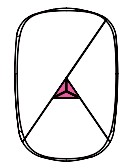
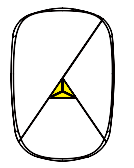
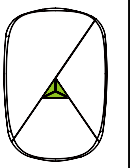
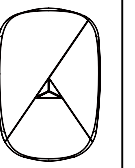

延時充電時間設定	8 小時	4 小時	2 小時	1 小時	無延時設定
面板燈號顏色	 粉紅色燈	 黃色燈	 青色燈	 白色燈	 綠色燈

(步驟 3) 延時充電的功能設定完成後，才可將充電槍插入電動車充電接口內。

(步驟 4) 完成延時充電設定後，將 RFID 感應卡貼近位於壁掛式充電器面板左側的 RFID 感應卡感應區，會聽到一聲「嗶」的聲音，表示感應成功，如下圖所示。

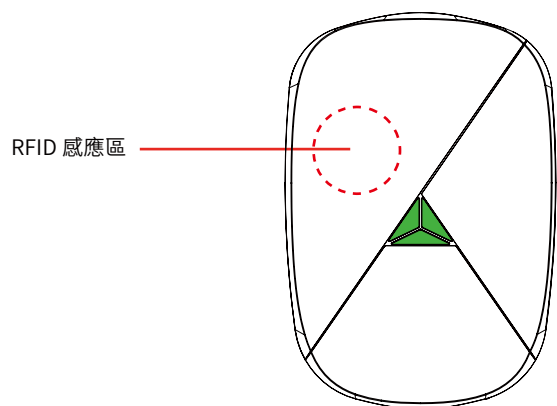

(步驟 5) 當 RFID 感應卡感應成功後，壁掛式充電器面板燈號會顯示延時充電時間對應的燈號顏色，表示開始計算延時充電時間，例如延時設定為 8 小時，則面板顯示為粉紅色燈，如下圖所示。

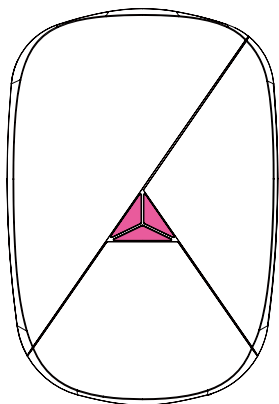

(步驟 6) 延時充電倒數計時結束後，壁掛式充電器面板燈號顯示藍色呼吸燈如下圖所示，表示已正在充電中，同步可從車端儀表確認相關充電資訊。

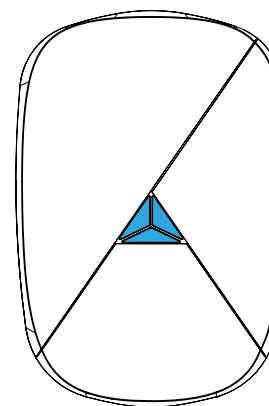

(步驟 7) 當車端資訊顯示充電完成時，壁掛式充電器面板燈號顯示綠色呼吸燈如下圖所示；或是充電過程中欲停止充電，請再將 RFID 感應卡貼近位於壁掛式充電器面板左側的 RFID 感應卡感應區，聽到一聲「嗶」的聲音後，即代表結束充電，並依該車型之停止充電解鎖程序完成後，再將充電槍自電動車充電接口脫離。

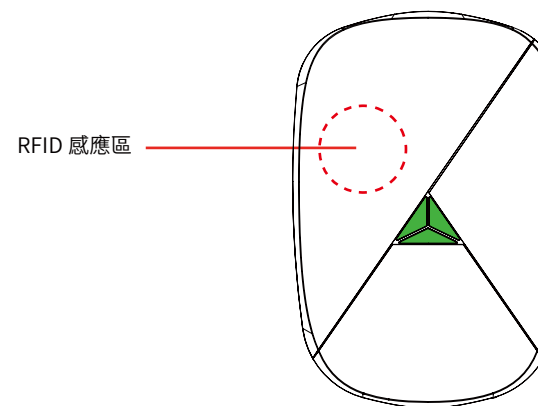

3.3 隨插即用充電操作步驟

⚠ **警告：**在未完成正常斷電程序步驟，切勿任意插拔充電槍，若造成設備或財物損壞及人員傷亡，華城電能皆不負任何法律責任與損害賠償責任，須自行負責。

(步驟 1) 開啟輸入電源側的漏電斷路器開關，當壁掛式充電器完成開機自我檢測後，面板燈號顯示為綠色呼吸燈如下圖所示，則表示已進入待機樁狀態 (如已開啟電力來源的漏電斷路器，此步驟可忽略)。

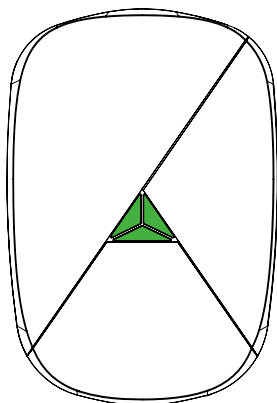

(步驟 2) 將壁掛式充電器的充電槍接到電動車充電接口內。

(步驟 3) 當壁掛式充電器面板燈號顯示藍色呼吸燈，表示已正在充電，同步可從車端儀表確認相關充電資訊。

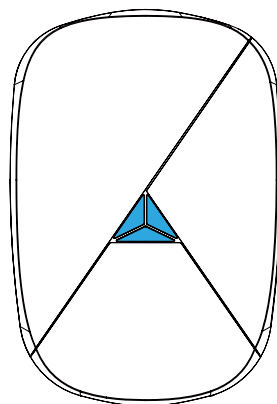

(步驟 4) 當車端資訊顯示充電完成時，壁掛式充電器面板燈號顯示綠色呼吸燈，如下圖所示，依該車型之停止充電解鎖程序完成，此時再將充電槍自電動車充電接口脫離。

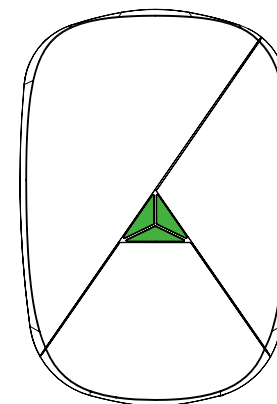

故障燈號顯示與排除

04

面板燈號表示之故障狀況以及排除方式進行說明如下表：

⚠ 若依循排除方式操作後，問題仍持續，請通知華城電能派人處理。

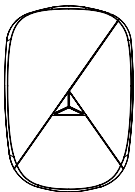
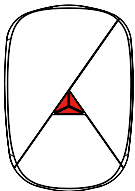
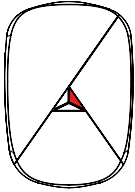
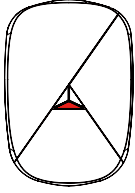
項次	面板燈號	故障說明	排除方式
1		沒有燈號，電源供應問題，無電源輸入，充電功能停用。	<ul style="list-style-type: none"> 請在雙手乾燥情況下將電力箱 (動力箱) 內的漏電保護器 (註 1) 重新開關，此步驟為先行排除是否為供電端的問題。
2		因按下緊急按鈕，面板燈號顯示紅色呼吸燈。	<ul style="list-style-type: none"> 將緊急按鈕往外拉，即可解除緊急按鈕鎖定。
3		右側燈恆亮紅燈，其餘不亮，為壁掛式充電器與車輛連結後超過 120 秒未刷 RFID 感應卡，或是已刷 RFID 感應卡但超過 120 秒未插槍，即未成功啟用充電功能。	<ul style="list-style-type: none"> 先插槍但超過 120 秒未刷 RFID 感應卡：請先將充電槍自車端移除後再重新插槍，並刷 RFID 感應卡。 先刷 RFID 感應卡但超過 120 秒未插槍： 請先等待 5 秒後機器自動回到待機模式，再重刷 RFID 感應卡。
4		下方燈恆亮紅燈，其餘不亮，為充電槍與電動車充電接口連結後，同時已刷 RFID 感應卡，但機器未偵測到來自車端的訊號，即未成功啟用充電功能。	<ul style="list-style-type: none"> 請確認充電槍是否確實插入電動車充電接口及重新感應卡片。

* (註 1) 漏電保護器：開關往上板是 ON，往下板是 OFF

項次	面板燈號	故障說明	排除方式
5		下方及右側燈恆亮紅燈，其餘不亮，為壁掛式充電器偵測到車輛充電電流過高，超出設定值，自動進入保護模式停止供電。	<ul style="list-style-type: none"> 請在雙手乾燥情況下將電力箱（動力箱）內的漏電保護器〔註 1〕重新開關，此步驟為先行排除是否為供電端的問題。
6		左側燈恆亮紅燈，其餘不亮，為壁掛式充電器偵測到電壓過高或過低，充電功能停用。	<ul style="list-style-type: none"> 請在雙手乾燥情況下將電力箱（動力箱）內的漏電保護器〔註 1〕重新開關，此步驟為先行排除是否為供電端的問題。
7		左側及下方燈恆亮紅燈，其餘不亮，為壁掛式充電器內建電錶偵測電源及通訊異常。	<ul style="list-style-type: none"> 請在雙手乾燥情況下將電力箱（動力箱）內的漏電保護器〔註 1〕重新開關，此步驟為先行排除是否為供電端的問題。
8		左右側燈恆亮紅燈，其餘不亮，為壁掛式充電器內部偵測溫度異常。	<ul style="list-style-type: none"> 請在雙手乾燥情況下將電力箱（動力箱）內的漏電保護器〔註 1〕重新開關，此步驟為先行排除是否為供電端的問題。

項次	面板燈號	故障說明	排除方式
9		左右側及下方燈亮紅燈 1 秒，為 RFID 感應卡片號碼錯誤。	<ul style="list-style-type: none"> 請確認使用的 RFID 感應卡為該壁掛式充電器專屬認證過之卡片。

*〔註 1〕漏電保護器：開關往上板是 ON，往下板是 OFF



充電器品質保養

05

5.1 壁掛式充電器設備簡易保養

- 充電器表面如有灰塵或髒汙可用擰乾的抹布進行表面擦拭。
- 不可使用有機溶劑或揮發性液體擦拭，避免損壞充電器外殼及引起火災的風險。
- 長時間不使用充電器時，可在雙手乾燥情況下將電力箱（動力箱）內的漏電斷路器關閉。

5.2 壁掛式充電器產品保固說明

1. 壁掛式充電器保固的有效期為顧客完成安裝日起計算 24 個月。
2. 壁掛式充電器產品保固的保障範圍係指，在 24 個月內個人正常使用華城電能所製造的壁掛式充電器，包括充電器整體含內部電子元件、充電槍組。另外對於可明確提出證明為華城電能製造的產品瑕疵，華城電能將進行必要的維修或更換。
3. 壁掛式充電器產品非保固的範圍包含係指以下內容敘述：
 - 排除電力保險絲外，RFID 感應卡外。
 - 當檢視產品時在保固貼紙有破損、壁掛式充電器有被拆解、嚴重刮痕及機體因撞擊而產生凹陷等外觀狀況系判斷為人為破壞，產品雖於保固期限內，華城電能有權不提供全新商品更換及免付費維修服務，相關維修天數及費用會依照狀況提出報價，商品修復的保固日期計算方式為延續顧客第一次完成安裝日起計算 24 個月。
 - 用戶未依安裝及操作手冊內容所敘述在正常操作步驟下，導致壁掛式充電器故障損壞，產品雖於保固期限內，華城電能可不提供全新商品更換及免付費維修服務相關維修天數及費用會依照狀況提出報價，商品修復的保固日期計算方式為延續顧客第一次完成安裝日起計算 24 個月。
 - 因壁掛式充電器周圍存放環境或天災，不侷限於火災、地震、洪水、閃電以及其他環境情況，導致壁掛式充電器故障損壞，產品雖於保固期限內，華城電能可不提供全新商品更換及免付費維修服務相關維修天數及費用會依照狀況提出報價，商品修復的保固日期計算方式為延續顧客完成安裝日起計算 24 個月。
 - 華城電能授權的合格安裝人員，皆受過華城電能產品與安裝訓練，華城電能會對其安裝正確性及安裝品質負責。
 - 未經華城電能授權的安裝人員，或未依照說明書安裝的人員，華城電能無法對其安裝正確性及安裝品質負責。
 - 為確保本產品正確使用方式與使用安全，使用本產品前，請先檢閱 EVALUE 壁掛式交流充電器完整操作指引手冊內所有警告與注意事項，再安裝與使用壁掛式充電器。產品安裝、操作與維護請遵循指示使用。
 - **請注意：**若在不正確的安裝、或不正常操作下，造成設備或財物損壞及人員傷亡，華城電能科技股份有限公司（簡稱華城電能）皆不負任何法律責任與損害賠償責任，須自行負責。

5.3 免責聲明

針對上述內容未涵蓋的部分，華城電能不承擔本合約所載之補救措施以外的責任，包括但不限於任何產品無法使用、利益損失、業務損失，或是資料或軟體遺失、損毀、受損，或服務條款之責任。除本合約明確指出者外，華城電能不承擔任何衍生性、特別的、間接的、懲罰性損害之責任，或負責任何第三方提出的求償。

主型號：CSDA-X50A

系列型號：CSDA-X50A/CSDA-X50A-A1/CSDA-X50A-A2/CSDA-X50A-A3/CSDA-X50A-A5/

CSDAX50A-A6/CSDA-X50A-A6-MINI/CSDA-X50A-A8/CSDA-X50A-A9/ CSDA-X50A-B1 /

CSDA-X32B/CSDA-X32B-A8/ CSDA-X32B-A9

機種型號	額定電流 _A	輸出功率 _kW	充電槍規格
CSDA-X50A、CSDA-X50A-A1、CSDA-X50A-A2、 CSDA-X50A-A3、CSDA-X50A-A5、CSDA-X50A-A6、 CSDA-X50A-A6-MINI、CSDA-X50A-A8、CSDA- X50A-A9、CSDA-X50A-B1	50	11	SAE J1772
CSDA-X40A、CSDA-X40A-A1、CSDA-X40A-A2、 CSDA-X40A-A3、CSDA-X40A-A5、CSDA-X40A-A8、 CSDA-X40A-A9、CSDA-X40A-B1	40	8.8	SAE J1772
CSDA-X32A、CSDA-X32A-A1、CSDA-X32A-A2、 CSDA-X32A-A3、CSDA-X32A-A5、CSDA-X32A-A8、 CSDA-X32A-A9、CSDA-X32A-B1	32	7.04	SAE J1772
CSDA-X24A、CSDA-X24A-A1、CSDA-X24A-A2、 CSDA-X24A-A3、CSDA-X24A-A5、CSDA-X24A-A8、 CSDA-X24A-A9、CSDA-X24A-B1	24	5.28	SAE J1772
CSDA-X16A、CSDA-X16A-A1、CSDA-X16A-A2、 CSDA-X16A-A3、CSDA-X16A-A5、CSDA-X16A-A8、 CSDA-X16A-A9、CSDA-X16A-B1	16	3.52	SAE J1772
CSDA-X32B、CSDA-X32B-A8、CSDA-X32B-A9	32	7.04	TYPE2
CSDA-X24B、CSDA-X24B-A8、CSDA-X24B-A9	24	5.28	TYPE2
CSDA-X16B、CSDA-X16B-A8、CSDA-X16B-A9	16	3.52	TYPE2

華城電能科技股份有限公司

10656 台北市大安區復興南路 1 段 368 號 10 樓

免付費客服專線 0800-885-150

官方網站：www.evalue.com.tw

客服信箱：service@f-evalue.com

Made in Taiwan

Contents

1. Product Information.....	38
1.1 Device Appearance.....	39
1.2 Device Specifications.....	40
1.3 Package Contents.....	41
2. Preparation for installation.....	42
2.1 Electricity Leakage Breaker rated power/maximum output.....	43
2.2 Charger Installation Procedures.....	43
2.3 Wall-mount Charger Installation Procedures.....	44
3. Charging Procedures and Operations.....	54
3.1 Procedures for Charging with RFID Card Reader.....	55
3.2 Charging Time Extension Settings.....	57
3.3 Plug-and-play Charging Operating Procedures.....	60
4. Troubleshooting.....	62
5. Wall-mount Charger Maintenance.....	66
5.1 Wall-mount Charger Maintenance.....	67
5.2 Wall-mount Charger Warranty Information.....	67
5.3 Disclaimer.....	68

Important Safety Precautions

This operator's manual lists all the important instructions for the Electric Vehicle AC Charger (also known as Mercedes-EQ Series second generation wall-mount EV charger, hereinafter referred to as wall-mount EV charger). Be sure to always follow correct operating procedures and safety measures. Before installing and using this wall-mount charger for the first time, please read all warning notices and follow instructions. Please follow instructions for device installation, operation, and maintenance.

Please note: Fortune Electric Value will not be responsible for any legal liability or damage repair for damages to equipment, loss of properties, or injuries of individuals due to abnormal operations of the device.

While installing or operating the wall-mount charger, one must follow the subsequent safety precaution measures in this manual.

It is preferred that qualified personnel trained by Fortune Electric Value perform the installation and maintenance. Fortune Electric will not be responsible for any quality issues and inaccuracies of installations performed by personnel other than Fortune Electric trained staff.

Fire and electric shock related safety instructions

- Please do not install or operate the wall-mount charger in any flammable, combustible or volatile environments with chemicals or chemical fumes on site.
- Before installing or cleaning the wall-mount charger, the Electricity Leakage Breaker of the power must be turned off.

Warnings

While transporting the wall-mount charger, please consider it fragile and handle it with care. To prevent damages on the charger itself or its components, do not have the charger undertake any impact forces, contortions, tugging forces or entangle, drag, step on the charger.

Please pay extra attention to the safety of children and users while operating the wall-mount charger. Make sure children keep a safe distance away from the charger.

The wall-mount charger must be earthed circuit.

Select the specified type of certified Electricity Leakage Breaker in accordance with the maximum power output.

The wall-mount charger requires an independent power circuit. Do not split power with other equipment.

Make sure the voltage is above 200VAC while performing a minimum load current operation at the preliminary evaluation. When the voltage drops below 200VAC, the vehicle might be unchangeable due to low voltage.

Please strictly follow all parameters while installing the wall-mount charger so as to prevent any damage.

- The Electricity Leakage Breaker box must be waterproof.

- Spraying water or any type of liquid to the interior of the circuit breaker box is strictly prohibited as well as spraying liquid at the charger plug or submerging it into any liquids.
- Applying excess pressure to the wall-mount charger and the components of charger plugs, or damaging it with sharp objects are also prohibited.
- Forbid inserting fingers or foreign objects (e.g. wires, tools, or needles) into the wall-mount charger or the tip end of the charger plugs (the interior of the plugs).
- Please safely stow the charger plug into its holder after using to prevent it from dropping in water or pollutants.
- When the charger is unavailable due to damages found on the charging cable, the plug cable, or the charger itself, please stop using the charger. And notify Fortune Electric Value and arrange for repair and inspection.
- When the demands for repair or modification occur, please contact Fortune Electric Value and arrange for repair and inspection.
- Before completing normal disconnection procedures, please do not remove the charging plug from the car.
- Operating the wall-mount charger might affect the normal functions of medical devices and implantable electronic devices, e.g. Artificial Cardiac Pacemaker and Implantable Cardioverter Defibrillator. Please consult with your doctor before operating the charger.

Precautions

- The utilization of wall-mount chargers is limited for electric vehicles only.
- When emergency situations occur, for instance, electric shock on operating individuals, abnormalities on vehicles, please press the left-side red emergency stop button immediately to terminate charging.
- Utilizing generators as power sources is prohibited as such operation might possibly cause damages to the wall-mount charger.
- Fortune Electric Value will not be responsible for any legal liabilities or damage reparations for any property loss and personnel injuries caused by incorrect operation of the wall-mount charger.
- This charging device must be used with a certified non-fuse switch overload protector and leakage protection circuit breaker to comply with the national BSMI VPC (Voluntary Product Certification) certification requirements. If you have any questions about installation, please contact EVALUE for consultation or purchase qualified materials. If the non-fuse switch overload protector and leakage protection circuit breaker are not used, the user shall be responsible for the abnormality or other problems of the charging equipment.
- Do not use adapters or convert adapters.
- Do not use extender cords.

Product Information

01

1.1 Device Appearance

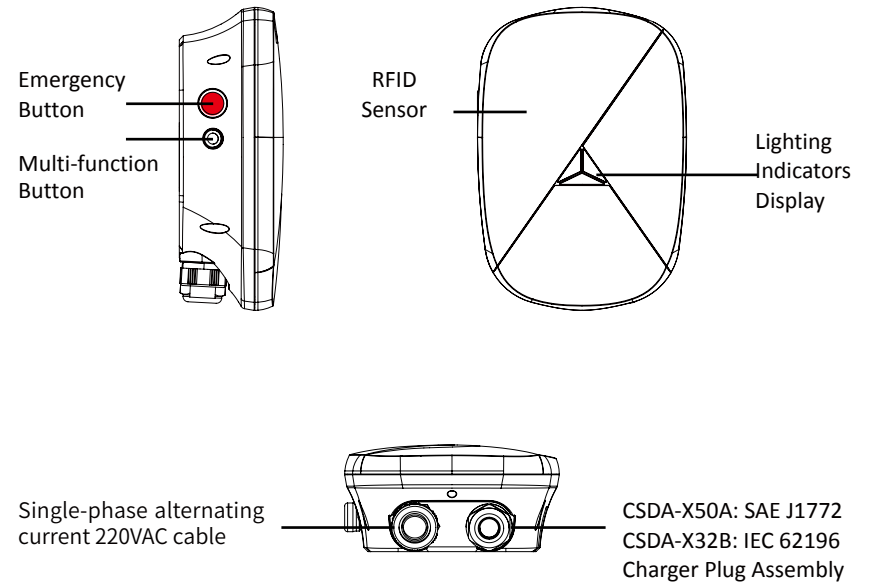



1.2 Device Specifications

Serial Model	CSDA-X32A,CSDA-X32B
Input voltage specification	Rated 200-240Volt single-phase alternating current
Output Current(A) / Power Output(kW)	32A / 7.04 kW
Frequency Range	60 Hz
Charger Plug Specification	CSDA-X32A: SAE J1772 / CSDA-X32B: IEC62196
Cable length	5 Meters
Wall-mount charger exterior dimensions	318 Length x 219 Width x 136 Depth (millimeter)
Weight of Wall-mount charger, including plug cable	9.62 Kilograms
Left-side button	Emergency Button, Multi-function Button
Lighting indicators	Stand-by - Green Charging - Blue Charging complete - Green Error - Red Optimized Charging: 8 hours/Pink, 4 hours/Yellow, 2 hours/Aquamarine blue, 1 hour/White
User identification	RFID Card Reader
WiFi Network	Wireless Network Function (Remark: This function only supports OCPP backend hosting server connection, household wall-mount charger not applicable.)
Safeguard functions	Over-voltage protection, Overcurrent protection, Electrical short protection, Leakage protection, Lightning protection, Low-voltage surge protection
Optimal operating temperature	-20°C to 50°C
Optimal storage temperature	-25°C to 70°C
Humidity	<95% Relative humidity
IP Waterproof rating	IP55

 Warning: Ensure optimal storage temperature is satisfied during transfer, transport, and storage of the wall-mount charger.

Note: Please check page 68 for complete series specifications.

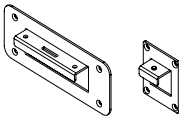
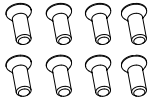
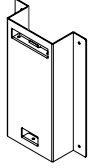
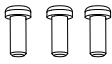
1.3. Package Contents

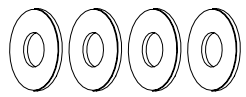
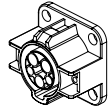
Item	Contents	Figure	Quantity
1	Wall mount: Metal brackets for securing charger on wall		2
2	Wall mount: Flat head screw (M3 X 8L)		8
3	Wall mount: Metal brackets for wall/charger pole		1
4	Wall mount: Pan head screw (M4 X 12L)		3
5	Cable hook		1
6	Hex socket head screw (M4 X 12L) for charger plug holder and cable hook		4
7	Washer		4
8	Charger plug holder		1
9	RFID Card and User Manual		1set

Preparation for installation

02

⚠ **Warning:** The wall-mount chargers shall be installed and maintained by qualified personnel trained by Fortune Electric. If the wall-mount charger was not installed by Fortune Electric and caused property loss and personnel injuries, Fortune Electric will not be responsible for any legal liabilities and damage reparations.

⚠ **Attention:** Please verify the maximum power load at the work site while performing the preliminary evaluation.

2.1 Electricity Leakage Breaker rated power/maximum output

In case of the maximum power output is 50 amp, please install the standard 2P/60 amp leakage breaker accordingly.

Below is the corresponding leakage breaker options for various power outputs:

Leakage Breaker(Amp)	Max Output(Amp)	Power Output kW(@220Vac)
20	16	3.5
30	24	5.2
40	32	7
50	40	8.8
60	50	11

2.2 Charger Installation Procedures

- Pencil or marker
- Electrical Plier
- Wire Stripper
- 2mm²~14mm² Crimping Plier
- Tape measure
- Analog Multimeter or Digital Multimeter
- Philip Screwdriver
- Small Flat Head Screwdriver
- Level
- Electric Drill and Drill Bits
- Plastic Expansion Anchors
- Circular Terminals R8-6
- Torque Wrench

2.3 Wall-mount Charger Installation Procedures

2.3-1 Use the wall mount metal pieces as guidance, mark drill positions as shown in below illustration

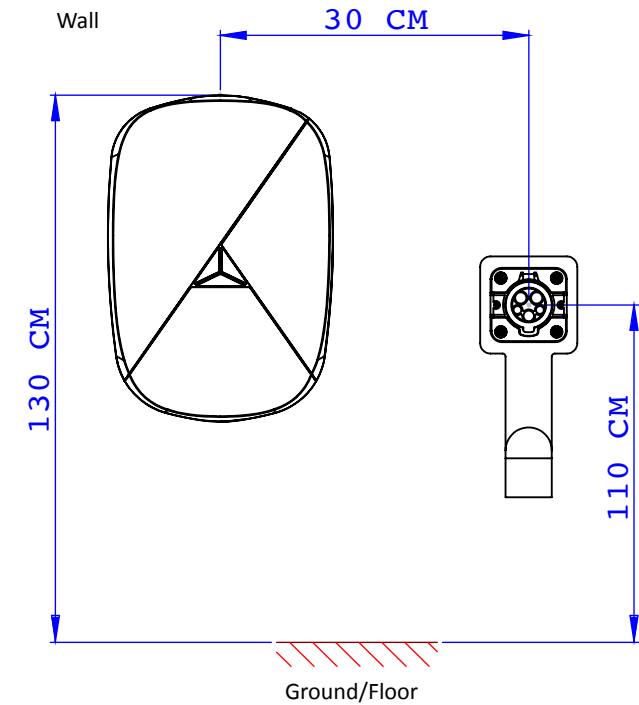
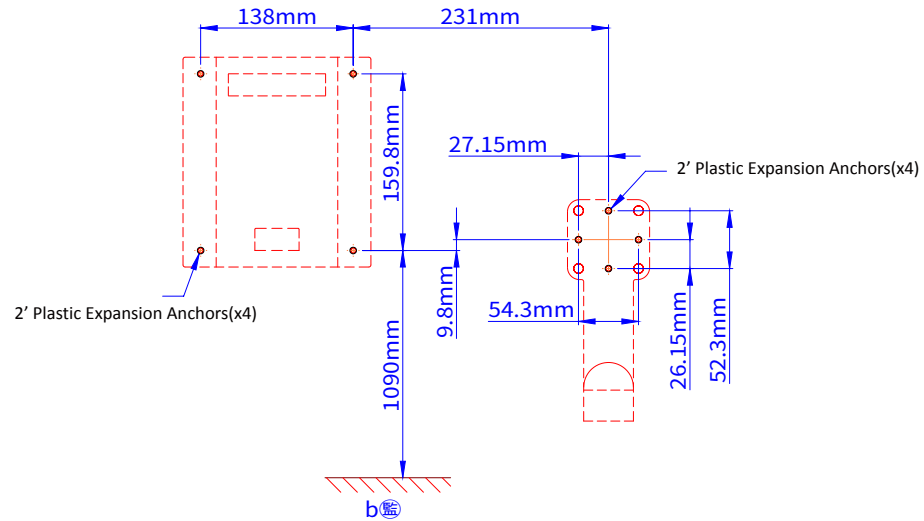

- Drill a hole with a 5.8mm concrete drill bit and insert the plastic anchors 6mm deep into the hole.
- Tighten screws and secure the wall mount (note the position of mount) on the wall.

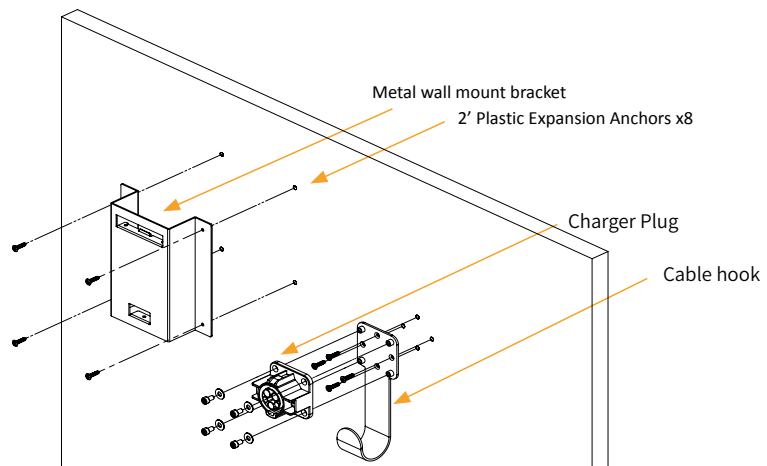

2.3-2 Wall mount metal pieces for the charger and cable hook installation procedures

- Secure the upper piece and the lower piece of the wall mount brackets onto the backside of the charger with the M3 flat head screws in the content package.
- Secure the cable hook at the lower right corner of the charger with the M4 pan head screws in the content package.

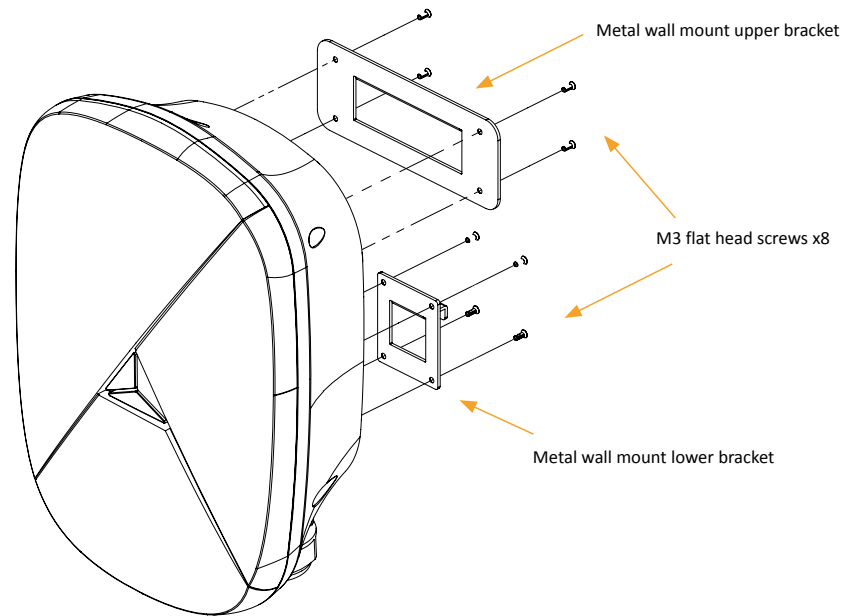

2.3-3 Preparation for Cable Installation

- Remove the rear access exterior cover and the interior cover with the Philip screwdriver.
- Remove the left and right sides and the bottom Philip flat head screws on the rear access exterior cover carefully and remove the cover.
- Remove the Philip pan head screws in all corners of the interior cover carefully and remove the interior cover.

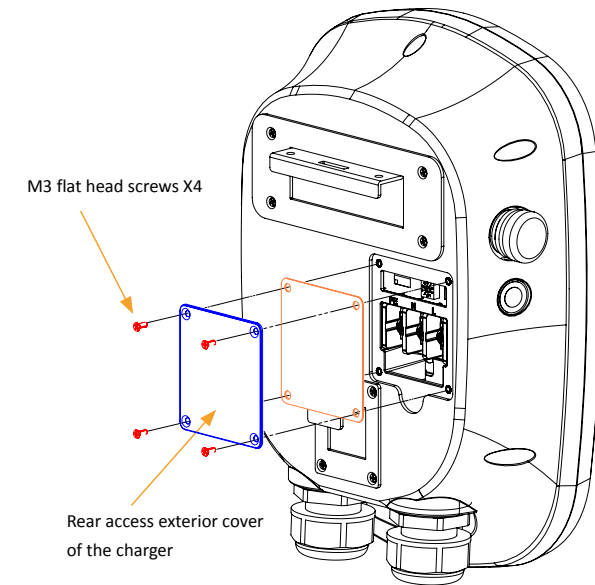

2.3-4 Verify the required current. Inspect and adjust the output current.

The default charging current on the wall-mount charger is set at 50 amp, adjusting the output current in accordance with the maximum power load at the work site. If adjustments are necessary, please refer to the chart below.

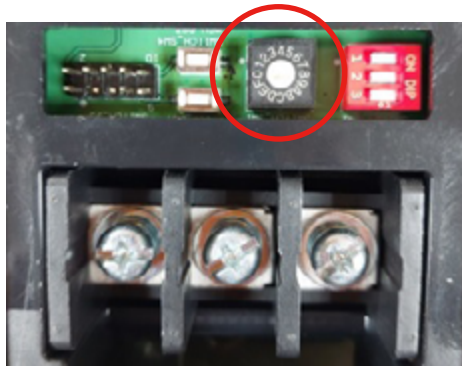

Adjustment switch of the output current

	Output Current
0	Default(50A)
1	40A
2	32A
3	24A
4	16A
5	—

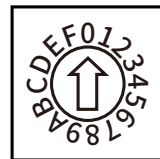

Output current adjustment basis

2.3-5 Setting the operation modes of the wall-mount charger

The wall-mount charger can be activated by either scanning the RFID card or by the plug-and-play mode. Settings of the corresponding modes as below:

⚠ Attention: Please ensure if extra RFID cards are needed and confirm user's setting preferences at the preliminary evaluation.

項目	指撥開關設定
RFID Card Reading	
Plug-and-play Function(default)	
Network Mode (Remark: This function only supports OCPP backend hosting server connection; It is not applicable to household wall-mount charger.)	
Full Function Mode	

2.3-6 Cable Installation

- For maximum power connection, the minimum wire requirement is 6 AWG (14mm²) ~ 90° C cable XLPE
- Connect the cable to the bottom entry of the main charger module and secure the cable on the terminals inside the charger module.
- Turn counterclockwise to loosen the cable connector, insert the cable 10 to 15cm in, turn clockwise and tighten the connector.
- Connect the L1 and L2 on the cable along with the ground wire to the circular terminals, use the torque wrench and connect to Lin \ Nin on the back of the charger (shown in below figure), then put the transparent cover back on (#Remark: The color of L1, L2, and GND vary in every country and district).
- Utilize the Analog Multimeter or Digital Multimeter and measure the voltage on the leakage breaker switch on the front of the charger main module, and verify the voltage at 220V±10%, then switch on the leakage breaker and verify the voltage on the terminals at the back of the charger.

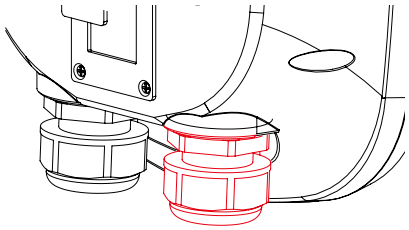

Cable insert location



Terminals inside the charger (on the back of the charger)

2.3-7 Electrification Inspection and Installation

- Secure the interior cover and the rear access exterior cover back on the charger in the reverse order they were removed (Ensure both covers are attached to the charger housing completely).
- Secure the charger on the wall mount or onto the charger pole.
- Secure the charger main module onto the metal bracket on the wall (shown in below figure) with the M4 pan head screws provided in the content package.

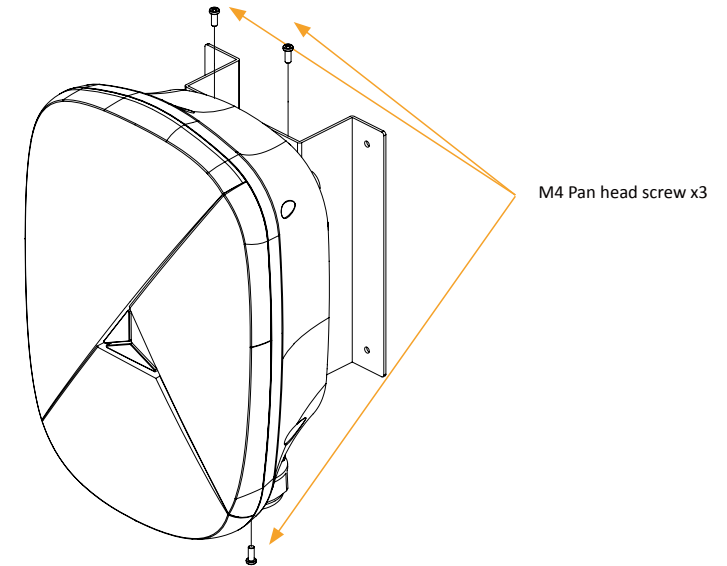

- Turn on the leakage breaker switch from the power source.
- After electrification, the charger is switched on, and with the charger's self-inspection complete, now the charger is in stand-by mode and shown in green breathing lights (shown in below figure).

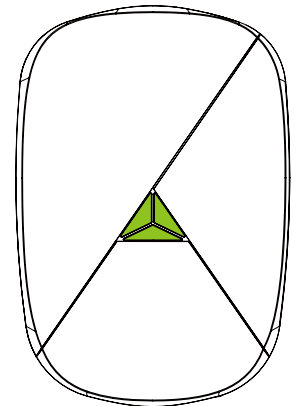

2.3-8 Circuit

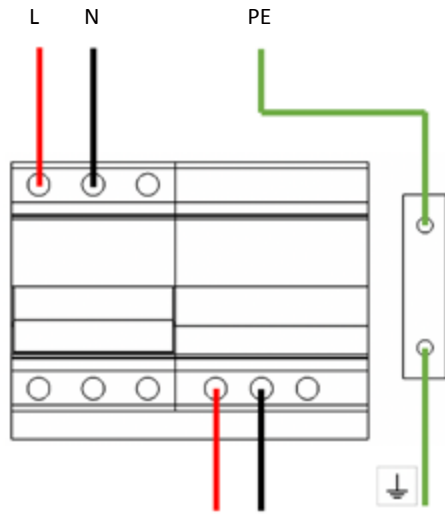

Type1

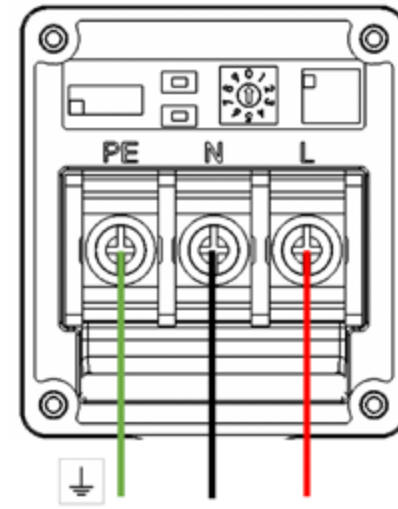

AC Input

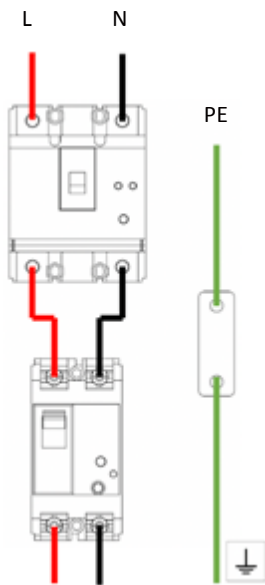

Type 2

Charging Procedures and Operations

03

3.1 Procedures for Charging with RFID Card Reader:

(Step 1) Turn on the leakage breaker switch and with the charger's self-inspection complete, green breathing light, as shown below. This indicates that it is in stand-by mode. (If the switch was already turned on, please skip this step.).

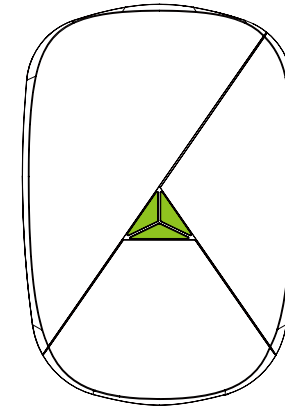

(Step 2) Plug in the charger into the charging port on the vehicle.

(Step 3) Move the RFID card close to the RFID sensor area (shown in below figure), wait for the "beep" sound.

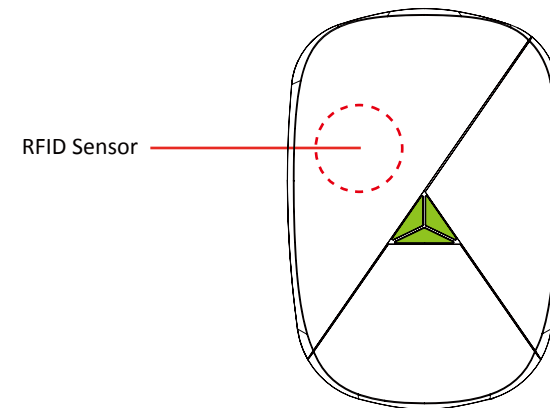

(Step 4) The indicator light turns green after successful reading, as shown in the picture below, and now the vehicle is being charged. This can also be verified via the in-car instrument cluster.

⚠ Attention: In case of hearing 3 short beeps and with the red indicator light shown, then turn into green breathing light, immediately after, this indicates the RFID card was not read successfully. Please check and only use the RFID card that comes in the content package, then please repeat from Step 3.

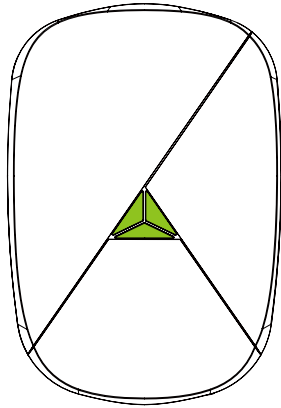

(Step 5) When the in-car instrument cluster shows “charging complete”, the indicator light on the wall-mount charger will show green breathing lights, as shown in the below picture. In addition, to stop the charging operation while charging, place the RFID card near the sensor area and hear the “beep” sound, and this indicates the charging operation has been stopped. After completing the corresponding unlocking procedures for the particular models, remove the charger plug from the vehicle charging port.

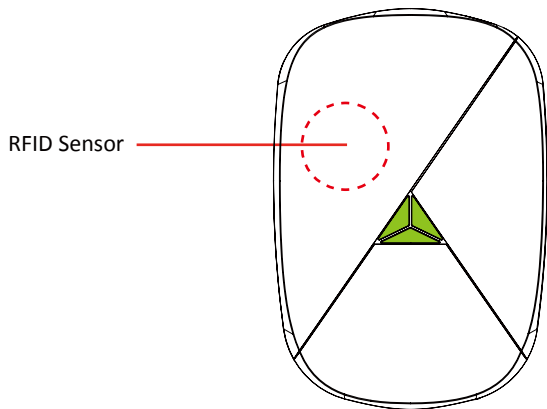

3.2 Charging Time Extension Settings



This charger is equipped with the Charging time extension function. The charging time extension options are 1, 2, 4, and 8 hours. Countdown will start after the desired setting is selected. Each extension period corresponds to different color, and operating procedures are the following:

⚠ Attention: This Charging time extension function varies with different vehicle models.

(Step 1) Turn on the leakage breaker switch and with the charger’s self-inspection complete, green breathing lights are shown in the picture below (If the switch was already turned on, please skip this step.).

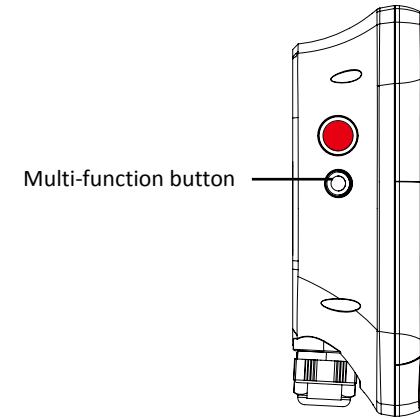
(Step 2) Long-pressing the multi-function button for 10 seconds enters the charging time extension function settings; select the corresponding color lights with charging time (shown in below figure), the extension time setting will be completed after 3 seconds.

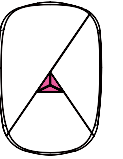
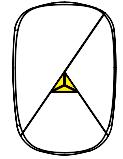
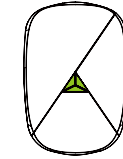

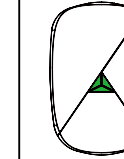
Charging time extension Setting	8 hours	4 hours	2 hours	1 hour	Back to default settings
Indicator Light Color	 Pink light	 Yellow light	 Aquamarine blue light	 White light	 Green breathing light

(Step 3) After the settings are completed, insert the charge plug into the vehicle charging port.

(Step 4) After completing the extension time settings, place the RFID card near the sensor area and hear the “beep” sound for setting confirmation, shown in the below picture.

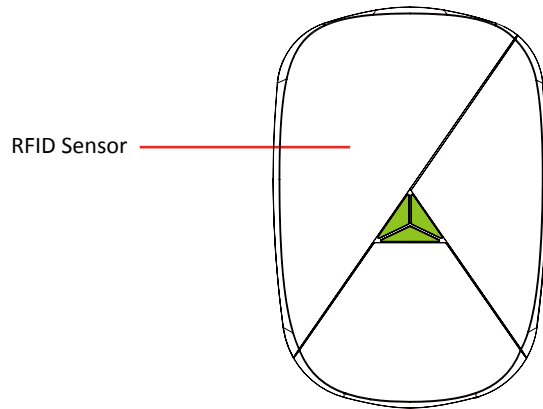

(Step 5) After successful reading, the indicator light will show the corresponding color light with the selected extension time as well as starting the countdown. For instance, if the extension time is set at 8 hours, then the indicator color light will show pink light, as shown below.

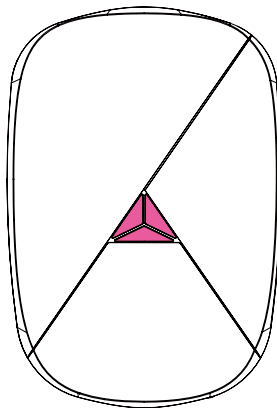

(Step 6) After the countdown completes, the indicator color light will show blue breathing light, as shown below. This indicates the charging is ongoing, and it can be verified via the in-car instrument cluster.

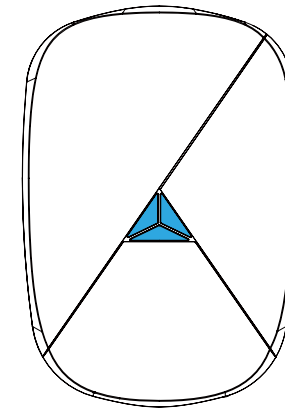

(Step 7) When the in-car instrument cluster shows “charging complete”, the indicator on the wall-mount charger will show green breathing light, as shown in the picture below. In addition, to stop the charging operation while charging, place the RFID card near the sensor area and hear the “beep” sound, and this indicates the charging operation has been stopped. After completing the corresponding unlocking procedures for the particular models, remove the charger plug from the vehicle charging port.

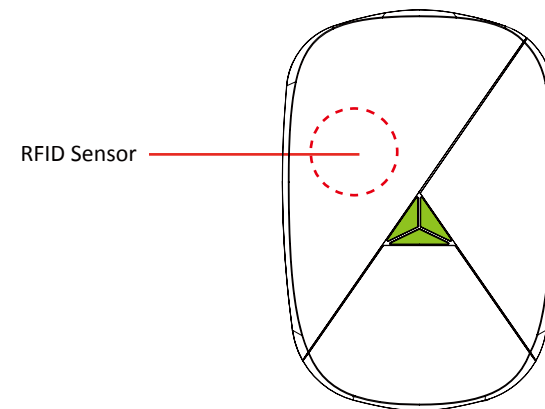

3.3 Plug-and-play Charging Operating Procedures

⚠ Warning: Before completing the normal charging procedures, please do not unplug or plug in the charger. In case of property losses or personnel injuries, Fortune Electric will not be responsible for any legal liabilities and damage reparations.

(Step 1) Turn on the leakage breaker switch and with the charger's self-inspection complete, green breathing lights are shown in the picture below (If the switch was already turned on, please skip this step.).

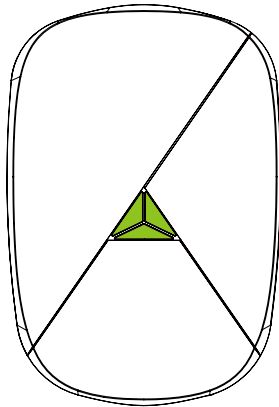

(Step 2) Plug in the charger into the charging port on the vehicle.

(Step 3) When the indicator color light shows blue breathing light, this indicates charging is ongoing, and this can be verified via the in-car instrument cluster.

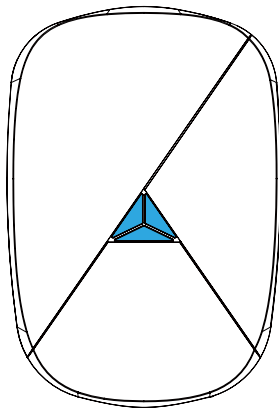

(Step 4) When the in-car instrument cluster shows "charging complete", the indicator on the wall-mount charger will show green breathing light, as shown in the picture below. After completing the corresponding unlocking procedures for the particular models, remove the charger plug from the vehicle charging port.

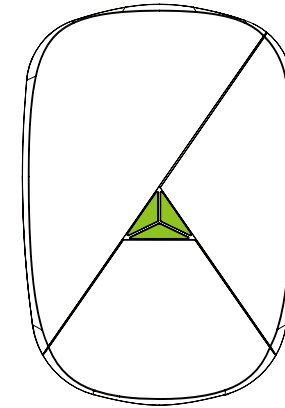

Troubleshooting

04

Corresponding error messages with indicator light patterns and correction methods are shown below:

 If operating according to the correction methods and the issue(s) persists, please notify Fortune Electric Value and arrange for repair and inspection.

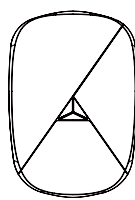
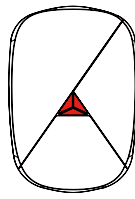
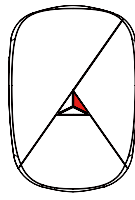
Item	Indicator Light	Error Message	Correction Method
1		No indicator light displayed. Power supply issue, no power, charging function not available.	<ul style="list-style-type: none"> Turn on the power switch (#Note1) again with dry hands. This procedure aims to exclude the power supply issue.
2		Emergency Stop button pressed, red indicator breathing light on.	<ul style="list-style-type: none"> Pull the emergency stop button and turn off the emergency stop function.
3		Right-side indicator light remains lit, the rest of the indicator lights remain dimmed. The charger plug is plugged into the vehicle charging port for over 120 seconds without reading the RFID card, or the charger isn't plugged in after the RFID card is read for over 120 seconds; this indicates that charging was not initiated successfully.	<ul style="list-style-type: none"> Charger plug plugged into the vehicle charging port for over 120 seconds without reading the RFID card: Remove the charger plug from the vehicle charging port, plug it back in, then place the RFID card near the sensor area. The charger isn't plugged in after the RFID card is read for over 120 seconds: Wait 5 seconds for the device to return to stand-by mode, then re-read the RFID card.

*Note1: Flick the power switch upward to turn on the charger, flick the switch downward to turn off the charger.

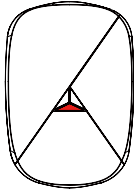
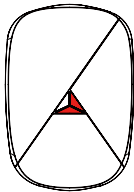
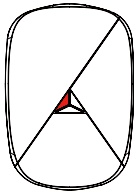
Item	Indicator Light	Error Message	Correction Method
4		underneath indicator light remains lit, the rest of the indicator lights remain dimmed. The connection between the charger and the vehicle is established and the RFID card is read, but the device did not detect the connection, thus, the charging function isn't activated successfully.	<ul style="list-style-type: none"> Please ensure the charger plug is indeed plugged into the vehicle charging port and re-read the RFID card.
5		Underneath and right-side indicator lights remain lit, the rest of the indicator lights remain dimmed. Overcurrent was detected by the wall-mount charger and over the intended value. The charger has gone into safe mode automatically and the power supply ceased.	<ul style="list-style-type: none"> Turn on the power switch (#Note1) again with dry hands. This procedure aims to exclude the power supply issue.
6		Left-side indicator light remains lit, the rest of the indicator lights remain dimmed. The wall-mount charger detected that the voltage is either higher or lower than the intended settings. The charging function is stopped.	<ul style="list-style-type: none"> Turn on the power switch (#Note1) again with dry hands. This procedure aims to exclude the power supply issue.

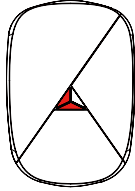
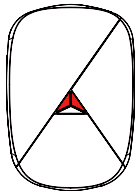
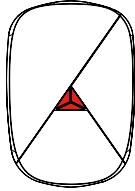
Item	Indicator Light	Error Message	Correction Method
7		Left-side and underneath indicator lights remain lit, the rest of the indicator lights remain dimmed. The wall-mount charger detected power or communication issues via its internal electric meter.	<ul style="list-style-type: none"> Turn on the power switch (#Note1) again with dry hands. This procedure aims to exclude the power supply issue.
8		Both the left-side and the right-side indicator lights remain lit, the rest of the indicator lights remain dimmed. The wall-mount charger detected internal temperature issues.	<ul style="list-style-type: none"> Turn on the power switch (#Note1) again with dry hands. This procedure aims to exclude the power supply issue.
9		All of the indicator lights remain lit for 1 second. The RFID card number is incorrect.	<ul style="list-style-type: none"> Please ensure the RFID card in use is indeed certified and exclusive for the use of the corresponding wall-mount charger.

*Note1: Flick the power switch upward to turn on the charger, flick the switch downward to turn off the charger.



Wall-mount Charger Maintenance

05

5.1 Wall-mount Charger Maintenance

- Wipe the surface of the wall-mount charger with lightly dampened cloth to clean dust and dirt.
- Avoid using organic solvents and volatile liquids to wipe the surface of the charger housing for possibly damaging the charger housing and the risk of fire.
- In case the charger is not in use for a long period of time, turn off the power switch inside the power box with dry hands.

5.2 Wall-mount Charger Warranty Information

1. The effective warranty period of the wall-mount charger lasts 24 months from the date of installation.
2. This provision explains what's covered under the warranty for the wall-mount charger. During the 24-month warranty period and with normal use, the warranty covers the entire charger module, including its internal electronic components and the charger plug. Fortune Electric will perform necessary repairs or replacement if proven manufacturing defects that are indeed truthful.
3. Items that are excluded from the warranty are described as below:
 - Fuses, RFID card
 - When discovered that the product warranty seal has been broken, the charger module has been disassembled, severe scratches, the charger module is dented due to blow or pressure, and all other external damages, of which were determined to be man-made; despite the product being under warranty, Fortune Electric reserves the right not to provide a new replacement product or repair the unit without appropriate charges. The corresponding repair period and associated fees will be determined and quoted. The warranty period of the repaired products remains at 24 months from the date of initial installation.
 - In the case that the installation was not in accord with this manual or users operate abnormally on the device, causing damages to the wall-mount charger; despite the product being under warranty, Fortune Electric reserves the right not to provide a new replacement product or repair the unit without appropriate charges. The corresponding repair period and associated fees will be determined and quoted. The warranty period of the repaired products remains at 24 months from the date of initial installation.
 - Due to the storage environment of the wall-mount charger or natural disasters, not limited to fire, earthquakes, floods, lightning, and all other environmental conditions, causing damages to the wall-mount charger; despite the product being under warranty, Fortune Electric reserves the right not to provide a new replacement product or repair the unit without appropriate charges. The corresponding repair period and associated fees will be determined and quoted. The warranty period of the repaired products remains at 24 months from the date of initial installation.
 - Qualified installation technicians authorized by EVALUE have been trained for the products of EVALUE and their installation. EVALUE is responsible for the

correctness and quality of installation.

- For installation workers not authorized by EVALUE or workers who do not follow the installation instructions, EVALUE cannot guarantee the correctness and quality of installation.
- To ensure that the product is used correctly and safely, it is advised to read and become familiar with the warnings and safety notes in the user's instruction manual of EVALUE wall-mounted AC charger before installing and using the wall-mounted charger. Please follow the instructions for the installation, operation and maintenance of the product.
- Please note: in case of equipment or property damage or casualty due to incorrect installation or operation, Fortune Electric Value Company Limited (referred to as EVALUE hereinafter) is not responsible for any liability or damage compensation.

5.3 Disclaimer

For parts not mentioned herein, Fortune Electric Value is not liable to remedies other than those covered in this manual, including but not limited to: the usability of the product, financial loss, business loss, loss of data, damages to software, and liabilities within terms of service. Apart from what's inclusive of this manual, Fortune Electric will not be responsible for any derivative, uncommon, indirect, punitive damages, or be liable for any claims from a third party.

Model: CSDA-X50A

Serial Model: CSDA-X50A/CSDA-X50A-A1/CSDA-X50A-A2/CSDA-X50A-A3/CSDA-X50A-A5/CSDA-X50A-A6/CSDA-X50A-A6-MINI/CSDA-X50A-A8/CSDA-X50A-A9/ CSDA-X50A-B1 / CSDA-X32B/CSDA-X32B-A8/CSDA-X32B-A9

Serial Model	Output Current(A)	Power Output(kW)	Charging gun SPEC
CSDA-X50A,CSDA-X50A-A1,CSDA-X50A-A2,CSDA-X50A-A3,CSDA-X50A-A5,CSDA-X50A-A6,CSDA-X50A-A6-MINI,CSDA-X50A-A8,CSDA-X50A-A9,CSDA-X50A-B1	50	11	SAE J1772
CSDA-X40A,CSDA-X40A-A1,CSDA-X40A-A2,CSDA-X40A-A3,CSDA-X40A-A5,CSDA-X40A-A8,CSDA-X40A-A9,CSDA-X40A-B1	40	8.8	SAE J1772
CSDA-X32A,CSDA-X32A-A1,CSDA-X32A-A2,CSDA-X32A-A3,CSDA-X32A-A5,CSDA-X32A-A8,CSDA-X32A-A9,CSDA-X32A-B1	32	7.04	SAE J1772
CSDA-X24A,CSDA-X24A-A1,CSDA-X24A-A2,CSDA-X24A-A3,CSDA-X24A-A5,CSDA-X24A-A8,CSDA-X24A-A9,CSDA-X24A-B1	24	5.28	SAE J1772
CSDA-X16A,CSDA-X16A-A1,CSDA-X16A-A2,CSDA-X16A-A3,CSDA-X16A-A5,CSDA-X16A-A8,CSDA-X16A-A9,CSDA-X16A-B1	16	3.52	SAE J1772
CSDA-X32B,CSDA-X32B-A8,CSDA-X32B-A9	32	7.04	TYPE2
CSDA-X24B,CSDA-X24B-A8,CSDA-X24B-A9	24	5.28	TYPE2
CSDA-X16B,CSDA-X16B-A8,CSDA-X16B-A9	16	3.52	TYPE2

Fortune Electric Value Co., Ltd.

10F., No. 368, Sec. 1, Fuxing S. Rd., Zhongshan Dist., Taipei City 104, Taiwan (R.O.C.)

Toll-free Customer Service Hotline 0800-885-150

Official Website: www.evalue.com.tw

Contact Us: service@f-evalue.com

Made in Taiwan

